

DV100

Dual View Trucks



**WACKER
NEUSON**
all it takes!



Dual View allows a clear view in every direction

With its 180° rotation of the entire operating and seat console the DV100 Dual View sets new standards in terms of operator and construction site safety, flexibility and economic efficiency. Additionally in the matter of material handling - with a skip volume of around 4,750 l - loads of stuff can be moved around.

- High driving position, high working position
- Hydrostatic drive
- More ease of use thanks to the ergonomic rotary console
- Comfort cabin

DV100 Technical specifications

Operating data

Payload	10,000 kg
Skip capacity - stroke	4,150 l
Skip capacity - heaped	5,000 l
Skip capacity - water measure	2,550 l
Engine / Motor	
Engine / Motor manufacturer	DEUTZ
Engine / Motor type	TD2.9 L4
Engine / Motor	water cooled 4 cylinder turbo diesel
Engine performance	55.4 kW
Displacement	2,900 cm ³
Engine RPM	2200 rpm
Emissions	level 3b / Tier IV final
Traction drive	4WD / hydrostatic
Travel speed max.	30 km/h
Articulation angle	28.3 °
Pendulum angle	11 °
Turning radius	6,765 mm
Gradeability	50 %
Tires	500/60-22.5
L x W x H	4,660 / 2,420 / 3,310 mm
Steering pump	axial piston pump
Flow rate	123 l/min
Operating pressure	480 bar
Duty pump	gear pump
Flow rate	70.2 l/min
Operating pressure	240 bar
Tank capacity	80 l
Sound level (LwA)	101 dB(A)

DV100 Dimensions

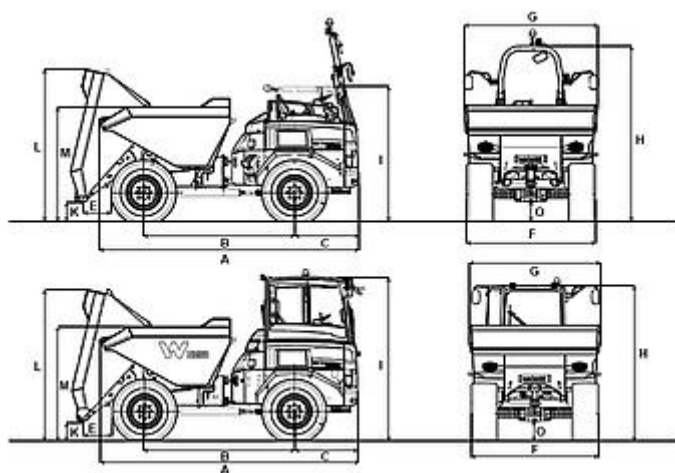

		Front tip skip
A	Overall length ROPS	4,660 mm
A	Overall length Cabin	4,660 mm
B	Wheelbase	2,700 mm
C	Rear overhang ROPS	1,157 mm
E	Dumping distance	549 mm
F	Width	2,420 mm
G	Skip width	2,504 mm
H	Height ROPS	3,382 mm
I	Height ROPS tilted	2,405 mm
J	Height Cabin	2,945 mm
K	Dump height max.	326 mm
L	Skip height tilted	2,723 mm
M	Skip height not tilted	2,041 mm
O	Ground clearance	358 mm
-	Dump angle	48 °

Please note: that product availability can vary from country to country. It is possible that information / products may not be available in your country. More detailed information on engine power can be found in the operator's manual; the stated power may vary due to specific operating conditions. Subject to alterations and errors excepted. Applicable also to illustrations.
Copyright © 2019 Wacker Neuson SE.