

Compact and wheeled excavators 6 to 15 tons



**WACKER
NEUSON**
all it takes!



Workhorses on any construction site: the compact and wheeled excavators from Wacker Neuson.

1. Economic efficiency that convinces.

Every construction site is different. That's why at Wacker Neuson you can choose the perfect machine for you from a finely tiered product range of compact and wheeled excavators – whether 6 tons or 15 tons, whether tracked or with wheels, whether with or without tail projection. In any case, you get a machine that is sturdy, powerful and easy to operate – and it is even more economical due to its versatility.

2. Quality that commits.

Our bundled excavator expertise is based in Hörsching near Linz. This is where our machines are developed, produced and sold to places all around the world. We ensure the highest quality standards in all process steps. After all, each of our excavators bears a special quality seal: "Made in Austria" reliability.

3. Customer proximity that leaves nothing to be desired.

Your requirements are our incentive. We not only offer you a large selection of excavators, but also a variety of attachments that you can use to expand your range of applications and that allow us to meet your needs even more individually. In addition, there are comprehensive services rendered for your machines: from individual financing solutions to professional maintenance. In this way, you can focus entirely on your projects.

Wacker Neuson—all it takes!

We offer products and services rendered that meet your high requirements and diverse applications. Wacker Neuson stands for reliability. This of course also applies to our extensive product range of excavators. We do our best every day to ensure your success. And we do this full of passion for our jobs.

Excavator expertise down to the last detail.



Efficiency

- **LUDV (load-independent flow distribution):** comfortable, fatigue-free control independent of the load to be moved
- **Thermal endurance:** constant work performance at ambient temperatures of up to 45 degrees Celsius
- **Wide range of options available ex work:** Individual equipment as desired

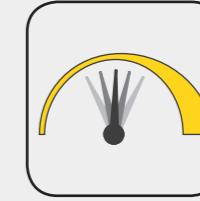

Versatility

- **Control circuits (AUX I-V):** up to 5 optional additional control circuits ex work
- **High machine utilization** due to numerous attachments ex work
- **Customer colors:** If desired, we also paint in special colors
- **Innovative front windshield system** for optimal ventilation in any weather

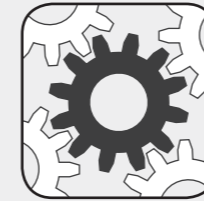

Maintenance

- **Optimal service accesses** thanks to the tiltable cabins
- **Long service life** thanks to the high-quality components and processes
- **Shortened maintenance:** Diagnostic tool WANDA makes troubleshooting easier



Security

- **Intuitive operation** via joystick display, jog dial and keypad
- **Large comfort cabin** with custom setting possibilities
- **Very good view** of the entire work area
- **Telematics** locate the machine per GPS and increase the anti-theft protection

All compact and wheeled excavators from 6 to 15 tons from this brochure in an overview.



ET65

Shipping weight: 5,806–6,682 kg



EZ80

7,588–8,877 kg
> Page 04



ET90

8,348–9,625 kg



ET145

Shipping weight: 14,917–15,701 kg
> Page 16



EW65

6,472–7,720 kg
> Page 22



EW100

9,241–10,461 kg
> Page 28

Other excavators of the < 6 ton mini-excavator weight class.

(More information in the brochure "Mini-excavator" or at www.wackerneuson.com)



B03

932–992 kg



ET16

1,402–1,602 kg



EZ17

1,596–1,822 kg



ET18

1,582–2,060 kg



ET20

1,862–2,182 kg



ET24

2,057–2,401 kg



EZ26

2,596–3,222 kg



ET35

3,418–4,335 kg



EZ36

3,507–4,452 kg



EZ53

4,968–6,165 kg

The ET65 with articulated boom and 3-point-kinematics is the flexible performance machine for quick cycle times

The EZ80 combines compact dimensions with excellent digging power – for best performances in a small space

The ET90 impresses with excellent engine and hydraulic performance - concentrated power that remains perfectly under control thanks to the load-sensing system

Power and efficiency times three: the tracked excavators ET65, EZ80 and ET90.

	ET65	EZ80	ET90
Shipping weight (kg)	5,806–6,682	7,588–8,877	8,348–9,625
Digging depth with short and long dipper stick (mm)	3,893*–4,193*	3,919–4,169	4,379*–4,679*
Engine output (kW)	36.3	36.2	55

* with articulated boom



Diesel particulate filter (optional) to meet country-specific statutory emission regulations

The most efficient drive on the market for high performances

Low tank filler point for easier refueling without climbing

Compact and maneuverable due to intelligent arrangement of the components and low height of machine

High stability due to a low center of gravity and optional additional rear counterweight

Optimal maintenance access for quick favorably priced service

Large and sturdy aluminum radiator easy to clean and with the best cooling performance in its class

Comfort cabin that can be adjusted to any operator size

100% power up to 45° C ambient temperature

8 large tie-downs for safe transport

Depending on the model, **different track versions** to choose from

Up to 7 headlights for the optimal illumination of the work area (optionally also LEDs)

Short hydraulic hoses for less power loss and a long service life

Versatile in use due to up to 5 additional control circuits ex work

Precise control with any load thanks to load-sensing hydraulic system with LUDV

3-point kinematics increases the insertion depth and digging force

Articulated boom for bigger digging radius and less repositioning (optional with ET65 and ET90)

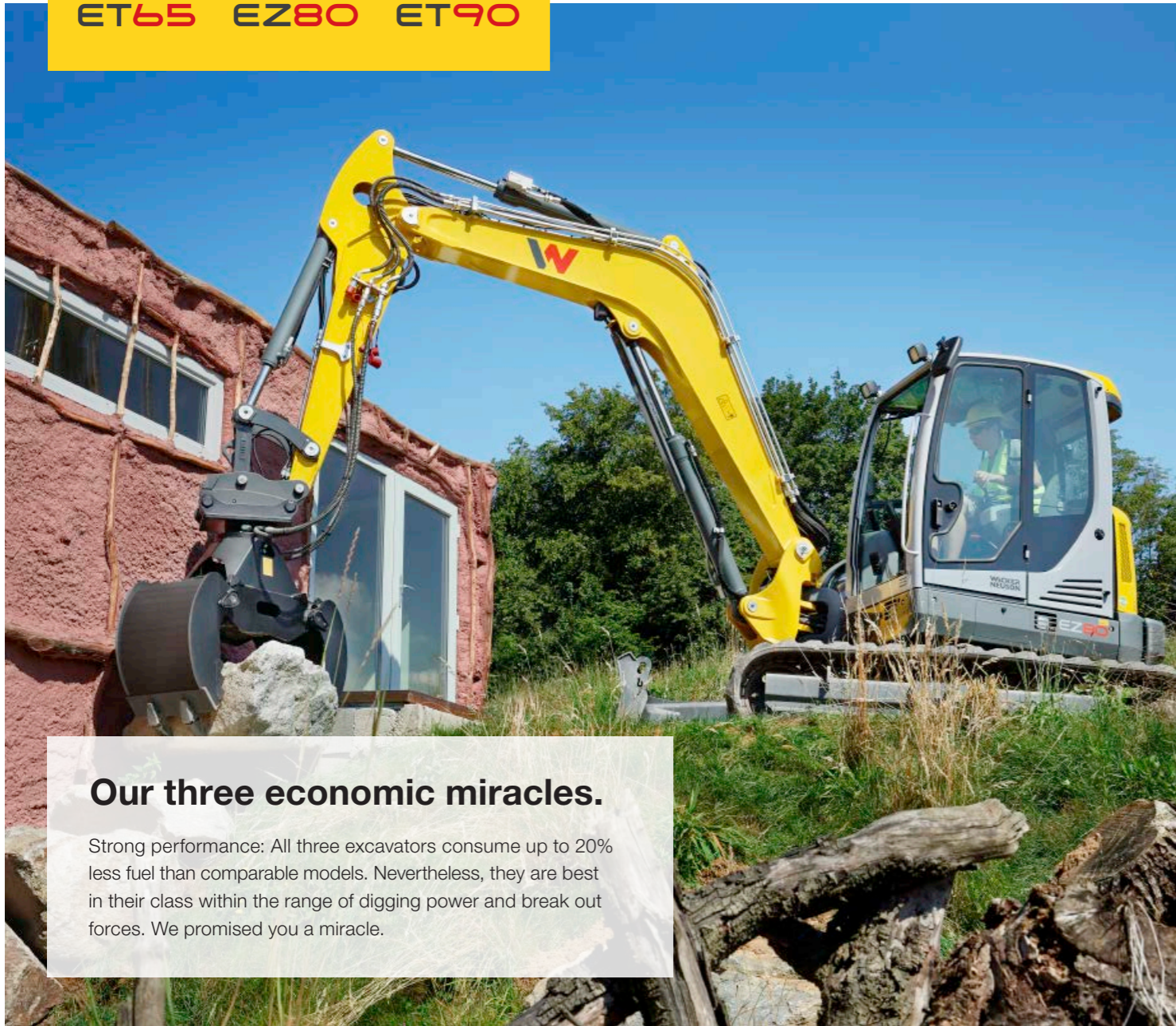

Our three economic miracles.

Strong performance: All three excavators consume up to 20% less fuel than comparable models. Nevertheless, they are best in their class within the range of digging power and break out forces. We promised you a miracle.

Unique 3-point kinematics.

The higher torque or the 3-point kinematics as well as the 200°-expanded angle of rotation make the ET65 and ET90 the best in their class in terms of digging power.

- Optimal insertion angle rotation of the bucket
- Digs even deeper vertically
- More powerful excavating
- Improved dumping behavior and less material loss

Up to
20 %
more
break out force

Vertical
insertion
depth:
+ 5 %



Total angle of rotation: 200°

More leeway thanks to articulated boom.

The articulated boom provides you with more maneuverability and therefore greater freedom of action. Because the additional joint permits the bucket to be pulled right up to the travel gear or the dozer blade. Ideal when narrow spaces need to be overcome or an obstacle has to be moved out of the way. The articulated boom is optionally available with the ET65 and ET90 - unique in these classes!



Available with
a short and long
dipper stick!

■ Monobloc boom
■ Articulated boom

High fuel savings
due to the efficient hydraulics with LUDV
(load-independent flow distribution).

Your benefits:

Up to
30% more
productivity



Up to
20% less
consumption



Articulated boom, optional for ET65 and ET90,
improves range, digging depth and dumping height.





Default settings at the touch of a push button:
by jog dial, e.g. save and access liter quantity or saving/retrieving release for attachments.

Ventilate flexibly and communicate easily –
thanks to the innovative windshield system without removing the panes.



More cabin comfort.

Maximum operating comfort is standard with the ET65, EZ80 and ET90. In addition, we offer you numerous options to adjust your excavator to your individual requirements. It's no surprise that the ET65 is even the best in its class in terms of cabin comfort.

Two-part windshields that can be completely slid under the cabin roof (standard equipment)

LED headlights for even better illumination

Optimal visibility

Powerful air-conditioning system for a pleasant working temperature at all times

Rear-view camera with 7" multifunctional display for an ideal view to the rear

Lateral sliding window

User-friendly jog dial with individually savable settings (standard equipment)

Air-cushioned comfort seat including seat heating for increased operator comfort and height adjustment





Attachment carrier with many application areas thanks to up to 5 additional control circuits



Individuality through variety.

Put together your perfect working unit from a variety of options available ex work, such as:

- Up to 5 additional control circuits, of which 3 are individually adjustable
- Diesel particulate filter
- Air-cushioned seat with heated seat
- 7 LED lights
- 4 track versions
- Custom-made paint finish in automotive quality
- Rear-view camera
- Automatic air-conditioning
- Counterweight
- Panolin hydraulic oil
- And much more

Hydraulically activated quickhitch system Easy Lock.

Change the attachment in a few seconds – using the Easy Lock hydraulic quickhitch system. For this purpose, the operator does not even have to get out and the new attachment is ready for use immediately. For even more flexibility and productivity.



Classic tool holding fixture, e.g. for excavation, done in a few seconds.



Reverse tool holding fixture, e.g. for moving or smoothing soil.

Powertilt: for the right setting.

The Powertilt swivel unit is available as an option and can be combined with both Easy Lock and the mechanical Lehnhoff quickhitch system. This allows the attachment to be rotated by up to 180° - ideal for leveling, mulching or demolition work.



Powertilt with hydraulic Easy Lock quick coupler system



Attachments for all applications.

Thanks to the optional additional control circuits, you can equip our excavators with a variety of attachments. Our product range includes all types of buckets, hydraulic hammers, adapter plates and much more. In this way, you can increase your application areas in no time and thus increase the utilization of your excavator.



Hydraulic hammers (kit available for every excavator)



Backhoe (with and without teeth)



Ditch or trench cleaning bucket



Swivel bucket



The EZ80 without tail projection makes safe and precise working possible directly against walls.



Safe entry and exit thanks to the low entry height.

Reduced dimensions.

Whether during transportation or in tight spaces: Thanks to their compact design, the ET65, EZ80 and the ET90 can easily take you to your next job site. And on the construction site, the machines can maneuver anywhere — even in confined spaces. You can benefit from high efficiency in all applications.

- Very low entry height
- Small dimensions due to the intelligent component arrangement
- Higher level of stability due to the low center of gravity

Simple maintenance. Simple repair.

The high productivity of our machines is not just due to the sturdy technology. Most service work can be completed in a short time due to quick and easily accessible maintenance points. Professional maintenance and repairs done by our technicians and original spare parts from Wacker Neuson also extend the service life of your machines.



Low emissions, high level of sustainability.

In terms of environmental compatibility, sustainability and low emissions, you are perfectly positioned with our compact excavators – even in the future. All machines meet the European emissions directives for the reduction of exhaust fume pollutants without you having to make compromises when it comes to performance, service life or economic efficiency. In order to achieve this, we only install the latest engine technologies that are equipped with various exhaust fumes aftertreatment systems. No exhaust after-treatment necessary is even necessary with the ET65 and EZ80. In addition, all three excavators are optionally available with a diesel particulate filter (DPF).

Productive like a 14-ton excavator and small and maneuverable like a compact excavator

Constant power engine for full power at any working speed and low consumption

Up to 5 additional control circuits, of which 3 are individually adjustable, for multifunctional attachments and extensive application areas



One of the largest compacts: the tracked excavator ET145.

	ET145
Shipping weight (kg)	14,917 – 15,701
Digging depth with short and long dipper stick (mm)	5,000 – 5,500
Engine output (kW)	55



Lower emissions with the same performance due to the diesel particulate filter (no SCR necessary)

2 pre-set operating modes: POWER or fuel-saving ECO mode

Large comfort cab with air-conditioning system standard

6 headlights for optimal lighting of the work area

Quiet engine for less noise pollution and easier communication

Intuitive operation of all excavator functions through the jog dial and display

Comprehensive application areas due to up to 5 additional control circuits

100% performance at up to 45 degree Celsius ambient temperature

Sturdy aluminum radiator improves the cooling performance and is easy to clean

Swivel console offers more flexibility in excavation work and saves time

3 tracked versions for any application

8 large tie-downs for simple, quick and safe loading

Standard dozer blade for maximum lift capacity and stability



The best of both worlds.

As one of the world's largest compact excavators, the ET145 combines the productivity of a large model with the advantages of a compact excavator, e.g.:

- High level of maneuverability
- Simple transport
- Different track versions
- High digging force, such as with much larger excavators

ET145 with swivel console for higher productivity.

The swivel console makes the ET145 into a real highlight in its weight class. This allows you an increased excavation area to the right and left. And because the machine needs to be moved much less, you save valuable time.

The swivel console ...

- allows you to work along walls and trenches
- facilitates work at obstacles such as pipes or flowing traffic
- improves the area of visibility, e.g. during excavation work in trench areas
- has a swiveling angle range of 70° left and 57° right

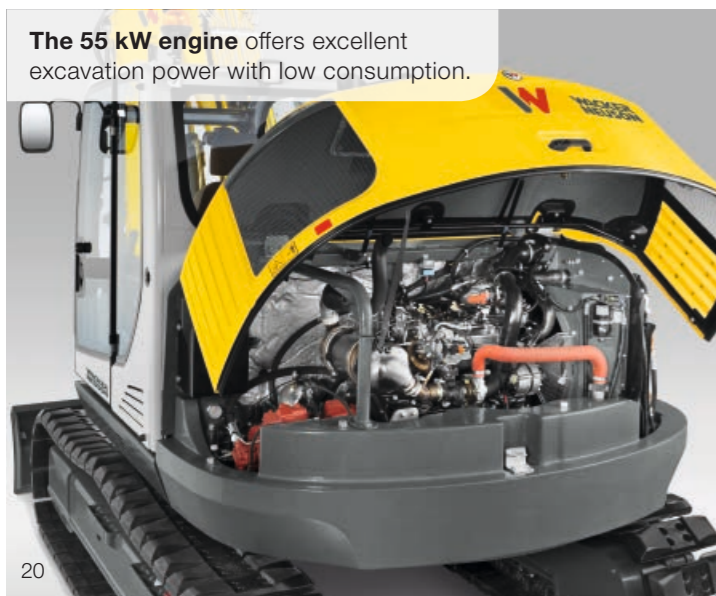

The 55 kW engine offers excellent excavation power with low consumption.

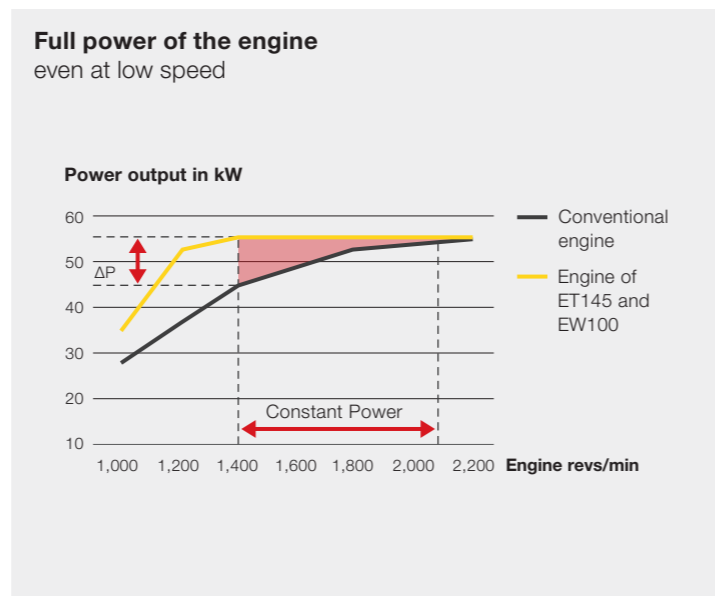

Large ergonomic comfort cabin: Sitting position, armrests and joystick can be individually adjusted.



Good traction and maneuverability in all ground conditions with the right track.

Articulated boom and 3-point kinematics for larger excavation radius, less repositioning and faster work cycles

Variable from 0 to 30 km/h without gear selection thanks to the closed driving circuit – easy operation with just one drive pedal

Precise control in the low and high load range thanks to load-sensing hydraulics with LUDV (load-independent flow distribution)

Power and speed, perfectly combined: the wheeled excavator EW65.

	EW65
Shipping weight (kg)	6,472–7,720
Digging depth with short and long dipper stick (mm)	3,596*–3,895*
Engine output (kW)	36.3

* with articulated boom



Two-piece windshield for variable ventilation and simple communication

Short hydraulic hoses thanks to the centrally positioned manifold block, therefore less power loss and longer service life of the hoses

Articulated boom for bigger digging radius and less repositioning

Simple operation selection: Full power (POWER) or save fuel (ECO)

The best thermal resistance in its class: Full performance at up to 45°C outside temperature

Cruise control, ideal for municipal work such as mowing, milling and mulching

The best cabin comfort in its class: Automatic air conditioning, seat heating, quiet engine and much more

Up to 5 additional control circuits available ex works, 3 of them individually adjustable

Easy maintenance due to tiltable cabin and removable chassis covers

3-point kinematics improves the break out force, insertion depth and dumping height

Environmentally sound and sustainable due to diesel particulate filter (optional)

Individual equipment due to a variety of options ex work

Optimal illumination of the work area (optionally with durable LEDs)

Durable aluminum radiator with high thermal resistance

Compact design for safe entry, simple transport and safe refueling

Move between construction sites quickly at up to 30 km/h without transport costs

6 large tie-downs for quick lashing down and secure transport

Individual support versions: Blade or stabilizer, rear, front or both sides

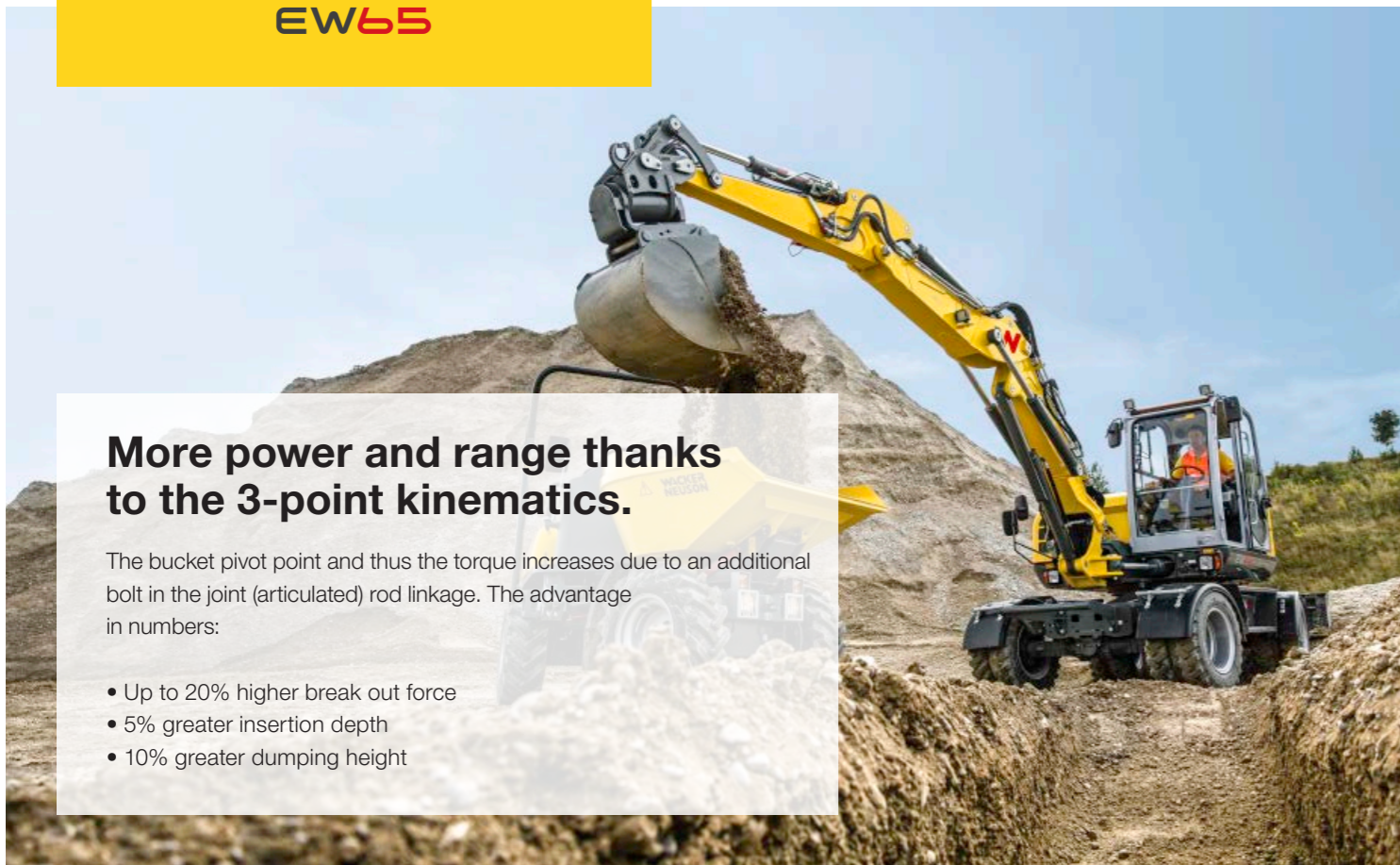

More power and range thanks to the 3-point kinematics.

The bucket pivot point and thus the torque increases due to an additional bolt in the joint (articulated) rod linkage. The advantage in numbers:

- Up to 20% higher break out force
- 5% greater insertion depth
- 10% greater dumping height

Both powerful and sensitive:
Thanks to the load-sensing hydraulics with LUDV (load-independent flow distribution), the power can be adjusted to the situation.



Sophisticated working area: The seat, armrests and joystick positions can be adjusted individually. The operation is simple and intuitive - identical to the ET65.

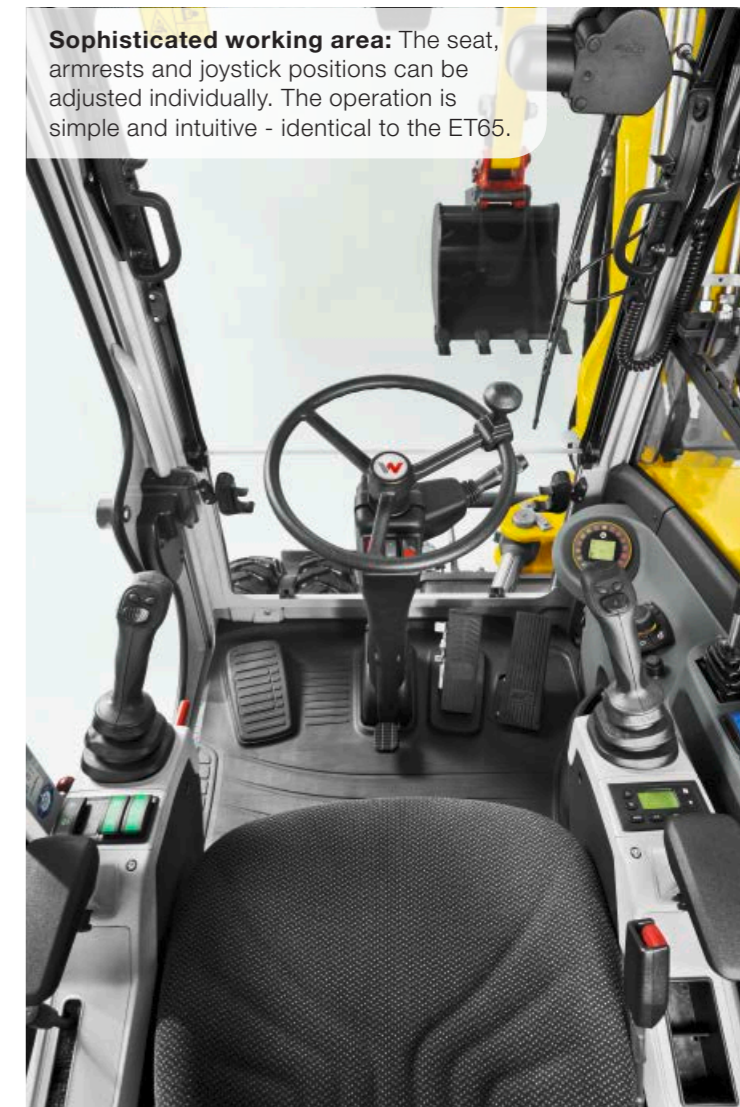

Increased stability.

A stable, good footing is essential - above all during heavy excavation work or on difficult ground conditions. For support, you can use a dozer blade or support stabilizers – both in front or in the rear or in any combination.

More leeway thanks to articulated boom.

Optionally available with the EW65, the articulated boom provides you with more maneuverability and therefore greater freedom of action. So not only can you excavate deeper, but the additional joint also makes it possible to pull the bucket all the way to the travel gear or the dozer blade. Ideal when narrow spaces need to be overcome or an obstacle has to be moved out of the way.



Innovative windshield system.

The two-part front window allows for optimal ventilation in the cabin in any weather. In addition, it makes it easier to communicate with the operator. A separate removal and storage of the window is a thing of the past.

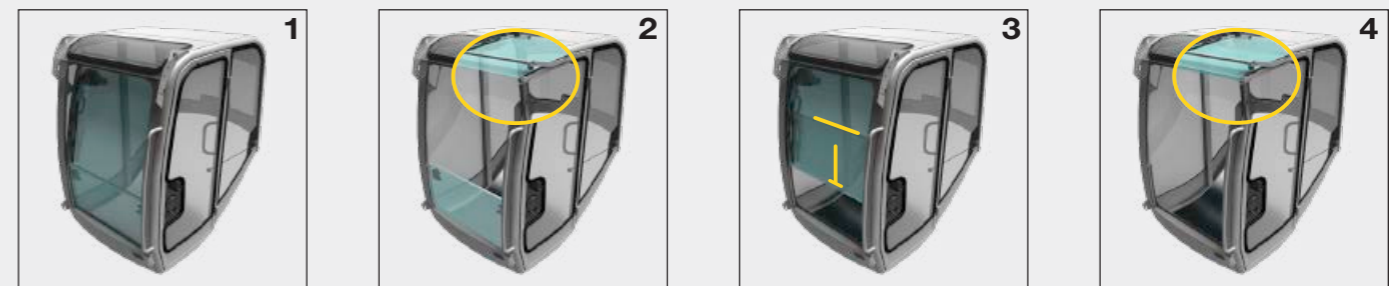

1 Closed windshield - two glass windows keep water and wind out.

2 The upper windshield can be pushed under the cabin roof. The lower pane serves as splash protection.

3 The lower windshield slides behind the upper one, making it ideal for talking with colleagues.

4 If necessary, both panes are pushed below the cabin roof where they are stored safely.

Closed travel circuit:
The speed can easily be
variably controlled via the
drive pedal – no gear change,
no rolling away on a slope

3 steering modes: Front
axle, all-wheel, crab steering
for optimal relocation in any
construction site situation

Comfortable, fatigue-free
control thanks to the load-
sensing hydraulic system with
LUDV (load-independent flow
distribution) – the joystick
movements always remain
the same for the operator

Productivity on wheels: of the wheeled excavator EW100.

	EW100
Shipping weight (kg)	9,241–10,461
Digging depth with short and long dipper stick (mm)	3,950–4,250
Engine output (kW)	55



Two operating modes to choose from: Full power (POWER) or save fuel (ECO)

Optimal ventilation and communication due to flexible windshield system

Optimally positioned manifold bloc: Hydraulic hoses are shorter and wear less, the efficiency is significantly increased

Up to 5 additional control circuits available ex work for numerous application areas

Illumination of the entire work area (optionally with LEDs)

Mudguards (optional) for reduced cleaning effort



Standard articulated boom increases the digging depth

The best thermal resistance in its class: 100% performance at up to 45 degrees ambient temperature

Cruise control, ideal for municipal work such as mowing, milling and mulching

Ergonomic cabin with individual adjustment of seat, joystick position and armrests

Intuitive operating concept: Simple control by joystick, display, jog dial and keypad

Load-sensing hydraulics with LUDV (load-independent flow distribution) for precise, fatigue-free control with all loads

Sturdy aluminum radiator, easy to clean

Large application radius on its own axles, standard up to 30 km/h (optionally up to 20 km/h)

Different stabilizer versions: Plate or stabilizer, rear, front or both sides

6 large tie-downs for quick, safe transport

More than an excavator.

The innovative hydraulics with load-independent flow distribution and up to 5 additional control circuits ex work make the EW100 into a true all-rounder. We are happy to provide you with the right attachments for this purpose.



From 0 to 30 km/h with one drive pedal for a quick location change without transport costs.



Large tiltable cab.

Optimal access to all important service areas: The cabin can be tilted to the side by about 60° and the chassis covers can be removed in a few simple steps. Repair work is thus quickly taken care of.



High excavation power and a deeper digging depth thanks to the articulated boom ensure a powerful excavation performance and quick cycle times.



Constant power engine.

Thanks to the constant power engine, the excavation performance of the EW100 remains consistently high, independent of the engine speed. That means:

- Full power even at low rpm
- Therefore less fuel consumption
- No SCR (selective catalytic reduction) required, therefore lower maintenance costs



Three steering modes.

The EW100 has three steering modes for various applications at the construction site as well as for road use. The steering method can be easily changed using a rocker switch.



Front wheel steering for fast driving on the road.



All-wheel steering for a particularly small turning circle.



Crab steering for parallel travel, e.g. along buildings.

Configuration options

COMPACT AND WHEELED EXCAVATORS

	ET65	EZ80	ET90	ET145	EW65	EW100
CABIN						
Standard cab	●	●	●	●	●	●
1-door cabin (sliding window)	●	●	●	●	●	●
FOPS protective grating level 1	●	●	●	○	●	○
FOPS protective grating level 2	○	○	○	○	○	○
Mirror package (left and right mirrors)	○	-	-	○	●	●
Side mirror (rear-view mirror)	○	○	○	●	○	○
Complete radio	○	○	○	●	○	○
Radio installation	●	●	●	●	●	●
Automatic air conditioning	○	○	○	●	○	○
Air-cushioned operator's seat	○	○	○	○	○	○
Front window protective grating	○	○	○	○	○	○
HYDRAULICS						
Overload warning device Advanced	○	○	○	●	●	●
Overload warning device Basic	●	●	●	-	-	-
Proportional control (for auxiliary hydraulics)	●	●	●	●	●	●
3rd proportional-controlled control circuit	○	○	○	●	○	○
BP-Biohyd SE46	○	○	○	○	○	○
Panolin HLP Synt46 (Bio)	○	○	○	○	○	○
Flat-faced coupler	○	○	○	○	○	○
Flow control valve 3rd control circuit	○	-	○	○	○	○
Flow control valve for auxiliary hydraulic	○	○	○	●	○	○
Control circuit for grapple	○	○	○	○	○	○
Easy Lock preparation	○	○	○	○	○	○
Powertilt preparation	○	○	○	○	○	○
PAINT						
Special paint 1 RAL	○	○	○	○	○	○
Custom paintwork 1 no RAL	○	○	○	○	○	○
Special paint cab/canopy RAL	○	○	○	○	○	○
SECURITY						
Security 24 C (2,000 h)	○	○	○	○	○	○
Security 36 C (3,000 h)	○	○	○	○	○	○
Security 48 C (4,000 h)	○	○	○	○	○	○

● Standard ○ Option - not suitable

COMPACT AND WHEELED EXCAVATORS

	ET65	EZ80	ET90	ET145	EW65	EW100
MISCELLANEOUS						
30 km/h	-	-	-	-	○	○
All-wheel steering	-	-	-	-	-	○
Mudguards	-	-	-	-	-	○
Rear-view camera	○	○	○	●	○	○
Particulate filter	○	-	○	●	○	●
Fluid Film	○	○	○	○	○	○
Telematics Europe 12 - 72 months	○	○	○	○	○	○
Cruise control	-	-	-	-	-	○
Standard rotating beacon	○	○	○	○	○	○
Front and rear work lights	○	○	○	●	○	○
LED headlights	○	○	○	-	○	○
Counterweight	○	○	○	-	-	-
Diesel filling pump	○	○	○	●	○	●
Automatic RPM speed control	●	●	●	●	●	●
Drive signal	○	○	○	-	○	○
Long dipper stick	○	○	○	○	○	○
Front or rear dozer blade	-	-	-	-	○	○
Front or rear stabilizer support	-	-	-	-	○	○
Articulated boom	○	-	○	-	○	●
Hose-rupture valve for bucket cylinder	-	-	-	-	-	○
Road traffic regulation accessories	-	-	-	-	○	○
Steering logic switch-over	-	-	-	-	-	○
Immobilizer system Digi Code or KAT	○	○	○	○	○	○
Tool box	-	-	-	-	-	○
Engine oil service valve	○	○	○	-	○	○
TÜV road homologation (Germany)	-	-	-	-	○	○
Rubber track	●	●	●	○	-	-
Hybrid track	○	○	○	○	-	-
Steel track*	○	○	○	●	-	-
Dual tires	-	-	-	-	○	●
Wide balloon tires	-	-	-	-	○	-
Balloon tires	-	-	-	-	●	○
ASSEMBLED ATTACHMENTS						
Easy Lock	○	○	○	-	○	○
Easy Lock + Powertilt	○	○	○	-	○	○
Easy Lock + Powertilt + Load hook	○	○	○	-	○	○
Lehnhoff mechan. quick coupler system	○	○	○	○	○	○
OilQuick + load hook	-	-	-	○	-	-
OilQuick + Powertilt + load hook	-	-	-	○	-	-

* different widths possible depending on the model

Dimensions

		ET65	EZ80	ET90	ET145	EW65	EW100	
DIMENSIONS		UNIT						
A	Height	mm	2,478	2,562	2,562	2,790 2,825 ⁽⁴⁾	2,775	2,980
B	Width of travel gear, retracted (track/tires)	mm	1,950	2,250	2,250	2,490	1,832 2,088 ⁽¹⁾	2,450
C	Transport length (short dipper stick)	mm	6,128 6,065 ⁽³⁾	6,939	7,117 6,468 ⁽³⁾	7,720	6,114 6,220 ⁽³⁾	7,255 6,656 ⁽³⁾
C	Transport length (long dipper stick)	mm	6,137 6,194 ⁽³⁾	6,944	7,139 6,690 ⁽³⁾	7,790	6,137 6,349 ⁽³⁾	7,315 6,886 ⁽³⁾
D	Max. digging depth (short dipper stick)	mm	3,826 3,893 ⁽³⁾	3,919	4,325 4,379 ⁽³⁾	5,000	3,531 3,596 ⁽³⁾	3,998 3,950 ⁽³⁾
D	Max. digging depth (long dipper stick)	mm	4,126 4,193 ⁽³⁾	4,169	4,625 4,679 ⁽³⁾	5,500	3,831 3,895 ⁽³⁾	4,298 4,250 ⁽³⁾
E	Max. vertical insertion depth (short dipper stick)	mm	2,383 2,764 ⁽³⁾	1,915	3,192 3,198 ⁽³⁾	3,100	2,088 2,465 ⁽³⁾	3,350 3,450 ⁽³⁾
E	Max. vertical insertion depth (long dipper stick)	mm	2,656 3,036 ⁽³⁾	2,124	3,474 3,456 ⁽³⁾	3,600	2,361 2,737 ⁽³⁾	3,650 3,750 ⁽³⁾
F	Max. insertion height (short dipper stick)	mm	5,773 6,537 ⁽³⁾	6,620	7,322 7,931 ⁽³⁾	8,300 ⁽⁵⁾	6,068 6,834 ⁽³⁾	7,295 8,090 ⁽³⁾
F	Max. insertion height (long dipper stick)	mm	5,955 6,770 ⁽³⁾	6,782	7,529 8,196 ⁽³⁾	8,600 ⁽⁵⁾	6,250 7,067 ⁽³⁾	7,485 8,355 ⁽³⁾
G	Max. dumping height (short dipper stick)	mm	3,912 4,664 ⁽³⁾	4,587	5,066 5,674 ⁽³⁾	5,700 5,659 ⁽⁴⁾	4,207 4,961 ⁽³⁾	5,160 5,935 ⁽³⁾
G	Max. dumping height (long dipper stick)	mm	4,094 4,898 ⁽³⁾	4,749	5,272 5,940 ⁽³⁾	6,000	4,389 5,195 ⁽³⁾	5,350 6,205 ⁽³⁾
H	Max. digging radius (short dipper stick)	mm	6,220 6,590 ⁽³⁾	6,955	7,331 7,596 ⁽³⁾	8,300	6,220 6,590 ⁽³⁾	7,540 7,815 ⁽³⁾
H	Max. digging radius (long dipper stick)	mm	6,504 6,877 ⁽³⁾	7,190	7,620 7,889 ⁽³⁾	8,800	6,504 6,877 ⁽³⁾	7,825 8,105 ⁽³⁾
I	Max. reach at ground level (short dipper stick)	mm	6,097 6,475 ⁽³⁾	6,795	7,179 7,463 ⁽³⁾	8,100	6,024 6,406 ⁽³⁾	7,320 7,605 ⁽³⁾
I	Max. reach at ground level (long dipper stick)	mm	6,387 6,772 ⁽³⁾	7,036	7,474 7,751 ⁽³⁾	8,600	6,318 6,706 ⁽³⁾	7,615 7,905 ⁽³⁾
J	Min. tail swing radius	mm	1,363	1,228	1,583	2,015	1,459	1,575
K	Max. boom offset to center of bucket (right/left)	mm	766/492	705/683	705/683	850/640	766/492	1,023/840
L	Max. stacking height of the dozer blade above subgrade (short/long)	mm	403	474	479	492/532 ⁽⁴⁾	395	504
M	Max. scraping depth of dozer blade under subgrade (short/long)	mm	427	523	518	531/493 ⁽⁴⁾	301	132
N	Total track length	mm	2,516	2,826	2,826	3,605	2,887	3,193
O	Max. swing angle of arm system to the right	°	63	63	63	57	63	63
P	Max. swing angle of arm system to the left	°	67	67	67	70	67	67
Q	Track/tire width	mm	400	450	450	500	300 457 ⁽¹⁾	514 ⁽¹⁾ 530 ⁽²⁾
R	Boom swing radius, center	mm	2,453 3,159 ⁽³⁾	2,869	2,503 2,840 ⁽³⁾	2,814	2,465 2,605 ⁽³⁾	2,953 3,190 ⁽³⁾

⁽¹⁾ Dual tires ⁽²⁾ Low pressure tires ⁽³⁾ with articulated boom ⁽⁴⁾ with hybrid track ⁽⁵⁾ with steel track

Tracked excavators

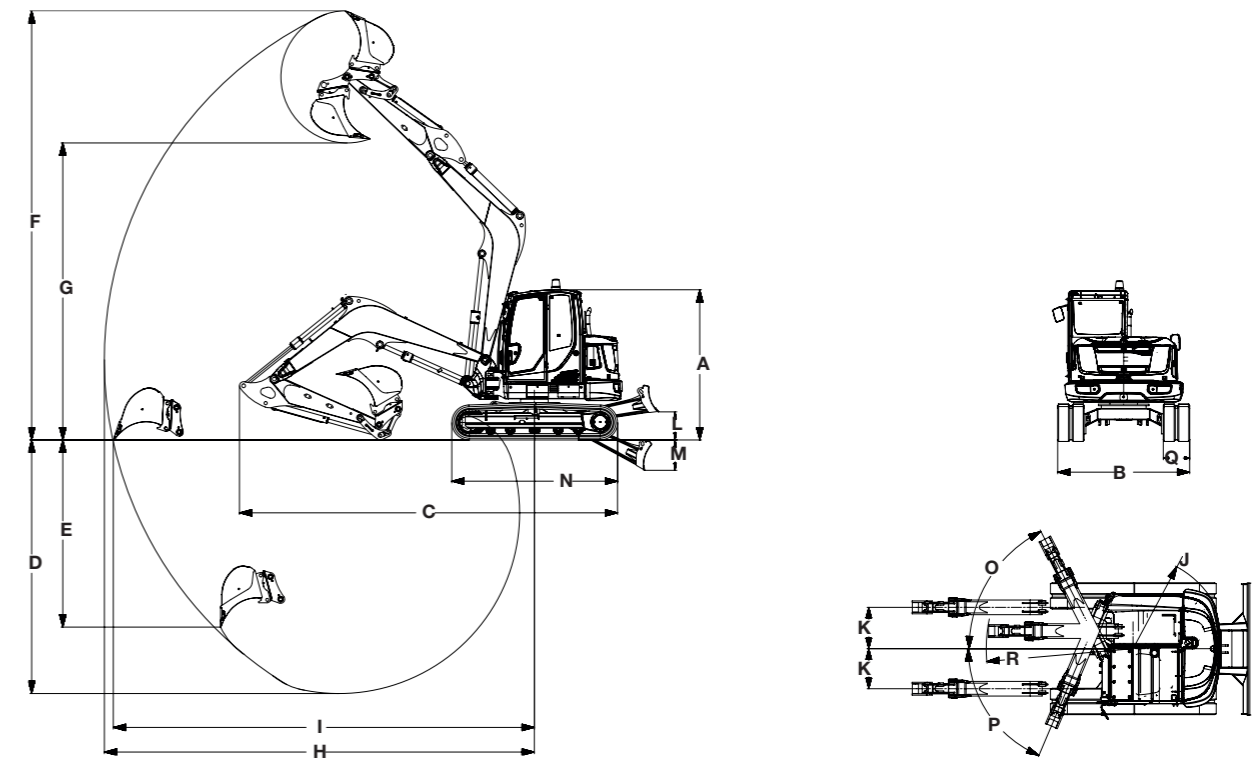

Wheeled excavators

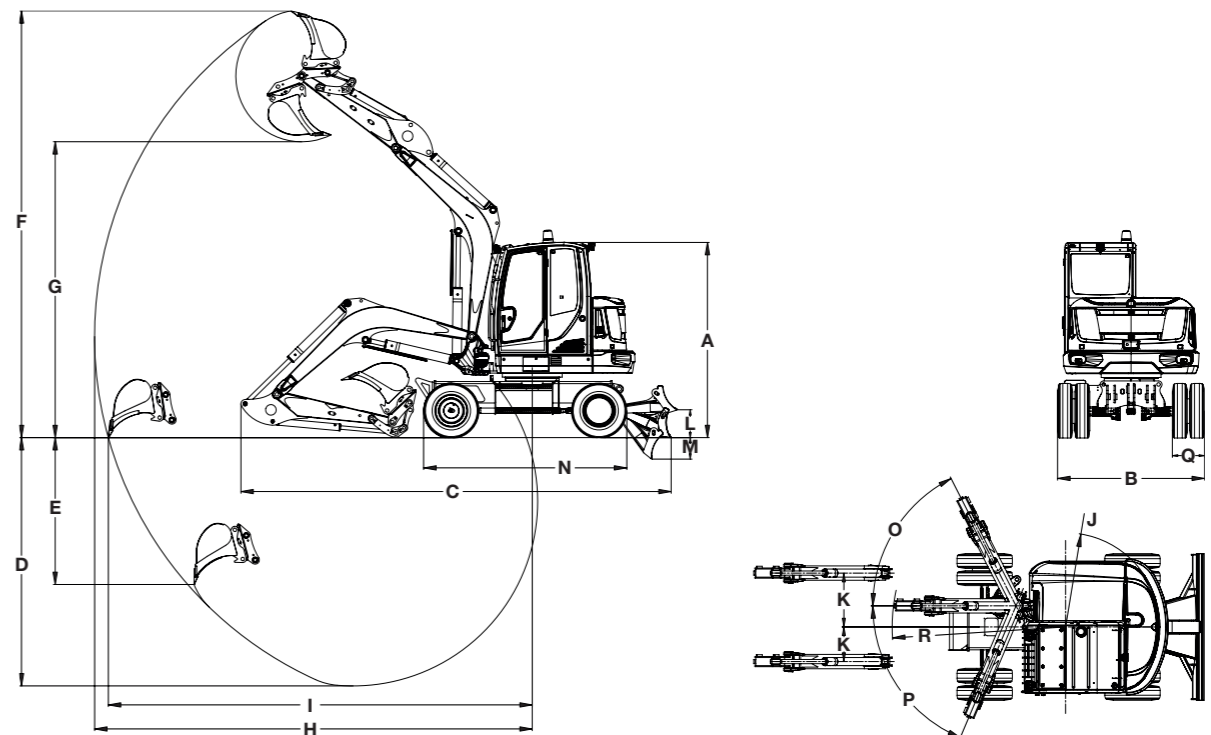

Your everyday work day is full of challenges.

We have the right solutions and help you to be ahead of the competition.

We offer you everything you need for this purpose: **Wacker Neuson—all it takes!**

Products

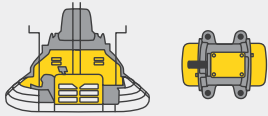

Concrete technology

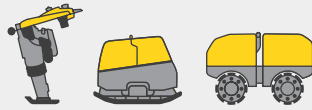

Compaction

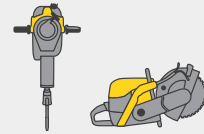

Demolition technology



Excavators



Wheel loaders



Telehandlers

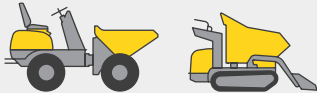

Dumpers

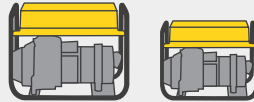

Generators

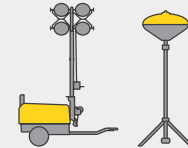

Lighting

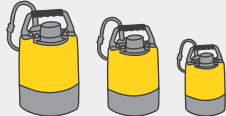

Pumps

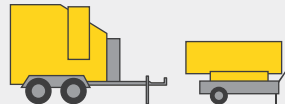

Heaters



Used equipment

Services



Financial solutions



Repair & maintenance



Academy



Rental



Telematics



The concrete specialists



eStore

Spare parts



www.wackerneuson.com



WN.EMEA.10291.V01.EN-US